

Space and working time saved with new heat sink construction. Series now includes 480-VAC models to allow use in a greater range of applications.

- A comprehensive lineup that now includes 480-VAC models.
- Slim design with 3-phase output and built-in heat sinks.
- New heat sink construction with smaller mounting section.
- DIN track mounting supported as standard. (Screw mounting is also possible.)
- Conforms to international standards (IEC, UL, and CSA).



## Ordering Information

### ■ Models with Built-in Heat Sinks

Applicable phase	Number of poles	Zero-cross function	Main circuit voltage	Applicable heater capacity (with Class-1 AC resistive load)	Model
3	3	Yes	100 to 240 VAC	5.1 kW max. (15 A)	G3PB-215B-3N-VD
	2				G3PB-215B-2N-VD
	3			8.6 kW max. (25 A)	G3PB-225B-3N-VD
	2				G3PB-225B-2N-VD
	3			12.1 kW max. (35 A)	G3PB-235B-3N-VD
	2				G3PB-235B-2N-VD
	3			15.5 kW max. (45 A)	G3PB-245B-3N-VD
	2				G3PB-245B-2N-VD
	3		200 to 480 VAC	12.5 kW max. (15 A)	G3PB-515B-3N-VD
	2				G3PB-515B-2N-VD
	3			20.7 kW max. (25 A)	G3PB-525B-3N-VD
	2				G3PB-525B-2N-VD
	3			29.0 kW max. (35 A)	G3PB-535B-3N-VD
	2				G3PB-535B-2N-VD
	3			37.4 kW max. (45 A)	G3PB-545B-3N-VD
	2				G3PB-545B-2N-VD

## Specifications

### ■ Ratings (at an Ambient Temperature of 25°C)

#### Operating Circuit (Common)

Item	Common
Rated operating voltage	12 to 24 VDC
Operating voltage range	9.6 to 30 VDC
Rated input current (Impedance)	10 mA max. (at 24 VDC)
Must-operate voltage	9.6 VDC max.
Reset voltage	1 VDC min.
Insulation method	Phototriac coupler
Operation indicator	Yellow LED

#### Main Circuit of Models with Built-in Heat Sinks

Item	G3PB-215B-3N-VD	G3PB-215B-2N-VD	G3PB-225B-3N-VD	G3PB-225B-2N-VD	G3PB-235B-3N-VD	G3PB-235B-2N-VD	G3PB-245B-3N-VD	G3PB-245B-2N-VD
Rated voltage	100 to 240 VAC							
Operating voltage range	75 to 264 VAC							
Rated carry current (see note)	15 A		25 A		35 A		45 A	
Minimum load current	0.2 A				0.5 A			
Inrush current resistance (peak value)	150 A (60 Hz, 1 cycle)		220 A (60 Hz, 1 cycle)		440 A (60 Hz, 1 cycle)			
Permissible I <sup>2</sup> t (half 60-Hz wave)	121 A <sup>2</sup> s		260 A <sup>2</sup> s		1,260 A <sup>2</sup> s			

Item	G3PB-515B-3N-VD	G3PB-515B-2N-VD	G3PB-525B-3N-VD	G3PB-525B-2N-VD	G3PB-535B-3N-VD	G3PB-535B-2N-VD	G3PB-545B-3N-VD	G3PB-545B-2N-VD
Rated voltage	200 to 480 VAC							
Operating voltage range	180 to 528 VAC							
Rated carry current (see note)	15 A		25 A		35 A		45 A	
Minimum load current	0.5 A							
Inrush current resistance (peak value)	220 A (60 Hz, 1 cycle)				440 A (60 Hz, 1 cycle)			
Permissible I <sup>2</sup> t (half 60-Hz wave)	260 A <sup>2</sup> s				1,260 A <sup>2</sup> s			

**Note:** Rated carry current varies depending on the ambient temperature. For details, refer to *Load Current vs. Ambient Temperature* in *Engineering Data*.

## ■ Characteristics

### Models with Built-in Heat Sinks

Item	G3PB-215B-3N-VD	G3PB-215B-2N-VD	G3PB-225B-3N-VD	G3PB-225B-2N-VD	G3PB-235B-3N-VD	G3PB-235B-2N-VD	G3PB-245B-3N-VD	G3PB-245B-2N-VD
<b>Operate time</b>	1/2 of load power source cycle + 1 ms max. (DC input)							
<b>Release time</b>	1/2 of load power source cycle + 1 ms max. (DC input)							
<b>Output ON voltage drop</b>	1.6 V (RMS) max.							
<b>Leakage current (see note)</b>	10 mA (at 200 VAC)							
<b>Insulation resistance</b>	100 MΩ min. (at 500 VDC)							
<b>Dielectric strength</b>	2,500 VAC, 50/60 Hz for 1 min							
<b>Vibration resistance</b>	10 to 55 Hz, 0.175-mm single amplitude							
<b>Shock resistance</b>	294 m/s <sup>2</sup> (98 m/s <sup>2</sup> with reverse mounting)							
<b>Ambient temperature</b>	Operating: -30°C to 80°C (with no icing or condensation) Storage: -30°C to 100°C (with no icing or condensation)							
<b>Ambient humidity</b>	Operating: 45% to 85%							
<b>Weight</b>	Approx. 1.25 kg		Approx. 1.45 kg		Approx. 1.65 kg		Approx. 2.0 kg	
<b>Approved standards</b>	UL508, CSA22.2 No. 14, EN60947-4-3 (IEC947-4-3) approved by VDE (From April 2001)							
<b>EMC</b>	Emission		EN55011 Group 1 Class B					
	Immunity		ESD		IEC947-4-3, EN61000-4-2			4 kV contact discharge
								8 kV air discharge
	Immunity		Electromagnetic		IEC947-4-3, EN61000-4-3			10 V/m (80 MHz to 1 GHz)
	Immunity		EFT		IEC947-4-3, EN61000-4-4			2 kV AC power-signal line
	Immunity		Surge transient		IEC947-4-3, EN61000-4-5			Normal mode ±1 kV, Common mode ±2 kV
	Immunity		RF disturbance		IEC947-4-3, EN61000-4-6			10 V (0.15 to 80 MHz)
	Immunity		Dips		IEC947-4-3, EN61000-4-11			

**Note:** The leakage current of phase S will be approximately  $\sqrt{3}$  times larger if the 2-element model is applied.

Item	G3PB-515B-3N-VD	G3PB-515B-2N-VD	G3PB-525B-3N-VD	G3PB-525B-2N-VD	G3PB-535B-3N-VD	G3PB-535B-2N-VD	G3PB-545B-3N-VD	G3PB-545B-2N-VD
<b>Operate time</b>	1/2 of load power source cycle + 1 ms max. (DC input)							
<b>Release time</b>	1/2 of load power source cycle + 1 ms max. (DC input)							
<b>Output ON voltage drop</b>	1.8 V (RMS) max.							
<b>Leakage current (see note)</b>	20 mA (at 480 VAC)							
<b>Insulation resistance</b>	100 MΩ min. (at 500 VDC)							
<b>Dielectric strength</b>	2,500 VAC, 50/60 Hz for 1 min							
<b>Vibration resistance</b>	10 to 55 Hz, 0.175-mm single amplitude							
<b>Shock resistance</b>	294 m/s <sup>2</sup> (98 m/s <sup>2</sup> with reverse mounting)							
<b>Ambient temperature</b>	Operating: -30°C to 80°C (with no icing or condensation) Storage: -30°C to 100°C (with no icing or condensation)							
<b>Ambient humidity</b>	Operating: 45% to 85%							
<b>Weight</b>	Approx. 1.25 kg		Approx. 1.45 kg		Approx. 1.65 kg		Approx. 2.0 kg	
<b>Approved standards</b>	UL508, CSA22.2 No. 14, EN60947-4-3 (IEC947-4-3) approved by VDE (From April 2001)							
<b>EMC</b>	Emission		EN55011 Group 1 Class B					
	Immunity	ESD	IEC947-4-3, EN61000-4-2 4 kV contact discharge 8 kV air discharge					
	Immunity	Electromagnetic	IEC947-4-3, EN61000-4-3 10 V/m (80 MHz to 1 GHz)					
	Immunity	EFT	IEC947-4-3, EN61000-4-4 2 kV AC power-signal line					
	Immunity	Surge transient	IEC947-4-3, EN61000-4-5 Normal mode ±1 kV, Common mode ±2 kV					
	Immunity	RF disturbance	IEC947-4-3, EN61000-4-6 10 V (0.15 to 80 MHz)					
	Immunity	Dips	IEC947-4-3, EN61000-4-11					

**Note:** The leakage current of phase S will be approximately  $\sqrt{3}$  times larger if the 2-element model is applied.

# Engineering Data

## ■ Load Current vs. Ambient Temperature (Continuous Input)

### Models with Built-in Heat Sinks

G3PB-215B-3N-VD G3PB-225B-3N-VD  
 G3PB-215B-2N-VD G3PB-225B-2N-VD  
 G3PB-515B-3N-VD G3PB-525B-3N-VD  
 G3PB-515B-2N-VD G3PB-525B-2N-VD

G3PB-235B-3N-VD G3PB-245B-3N-VD  
 G3PB-235B-2N-VD G3PB-245B-2N-VD  
 G3PB-535B-3N-VD G3PB-545B-3N-VD  
 G3PB-535B-2N-VD G3PB-545B-2N-VD

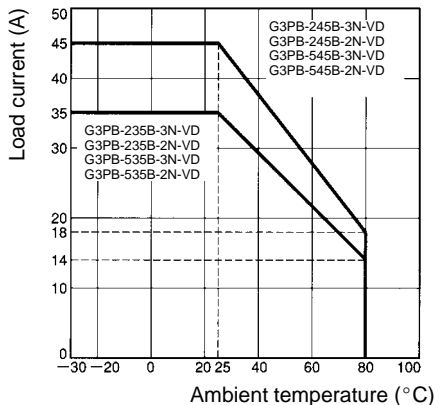
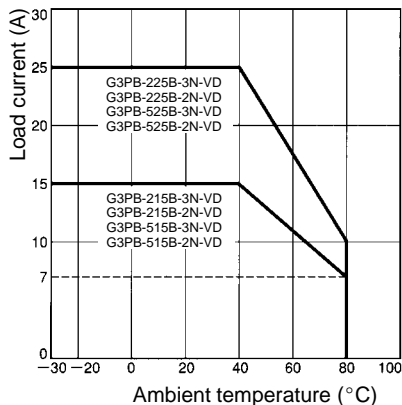

## ■ Inrush Current Resistivity: Non-repetitive (Less than Half for Repetitive)

G3PB-215B-3N-VD  
 G3PB-215B-2N-VD

G3PB-225B-3N-VD G3PB-225B-2N-VD  
 G3PB-515B-3N-VD G3PB-515B-2N-VD  
 G3PB-525B-3N-VD G3PB-525B-2N-VD

G3PB-235B-3N-VD G3PB-245B-3N-VD  
 G3PB-235B-2N-VD G3PB-245B-2N-VD  
 G3PB-535B-3N-VD G3PB-545B-3N-VD  
 G3PB-535B-2N-VD G3PB-545B-2N-VD

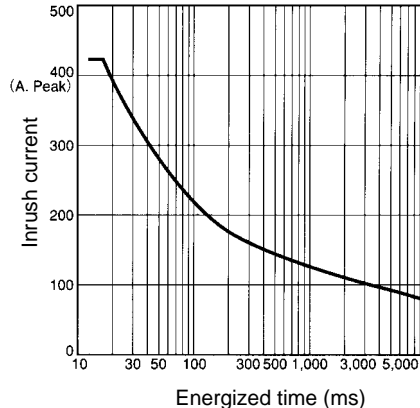
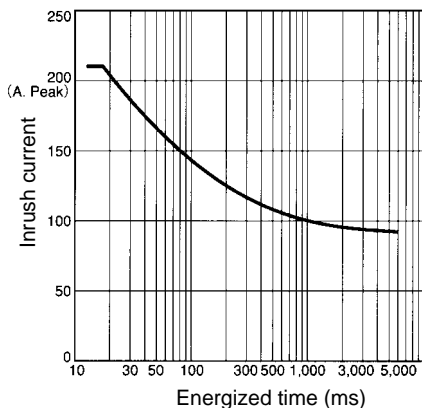
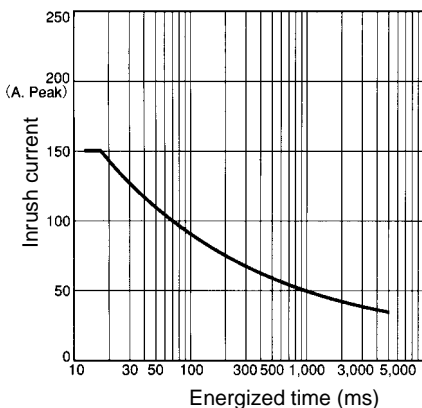

## ■ Input Voltage vs. Input Current and Input Voltage vs. Input Impedance

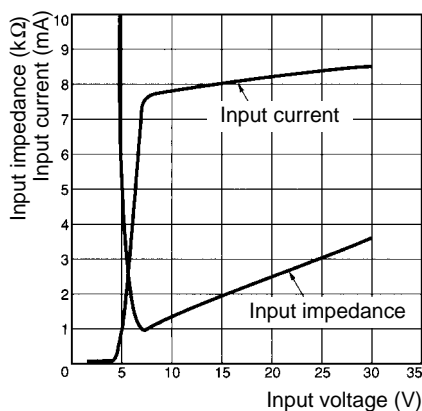

# Dimensions

**Note:** All units are in millimeters unless otherwise indicated.

G3PB-215B-3N-VD  
 G3PB-215B-2N-VD  
 G3PB-225B-2N-VD

G3PB-515B-3N-VD  
 G3PB-515B-2N-VD  
 G3PB-525B-2N-VD

**Without Terminal Cover**

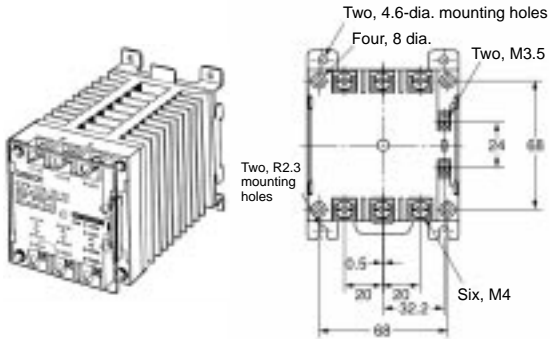

**With Terminal Cover**

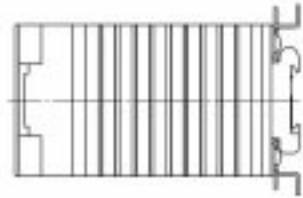
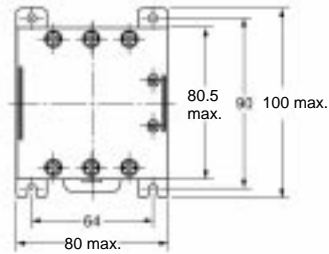

**Mounting Hole Dimensions**

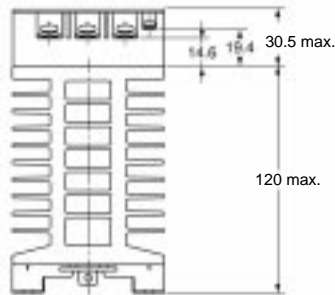
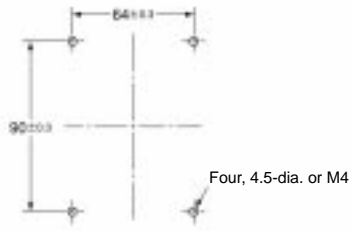

**Terminal Arrangement/ Internal Connections**

**G3PB-□□□B-3N-VD**

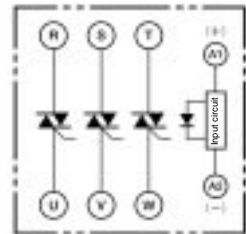

**G3PB-□□□B-2N-VD**

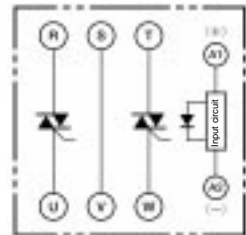

G3PB-225B-3N-VD  
 G3PB-235B-2N-VD  
 G3PB-525B-3N-VD  
 G3PB-535B-2N-VD

Without Terminal Cover

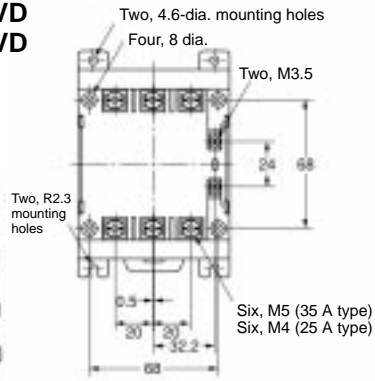

With Terminal Cover

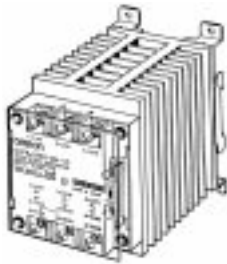
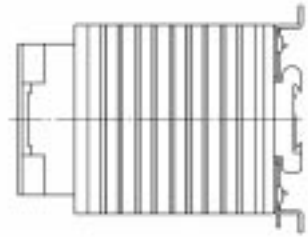
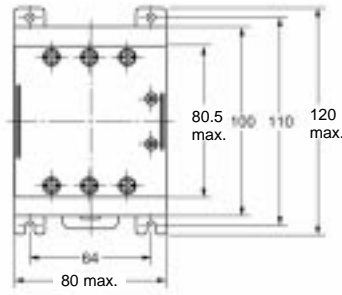

Mounting Hole Dimensions

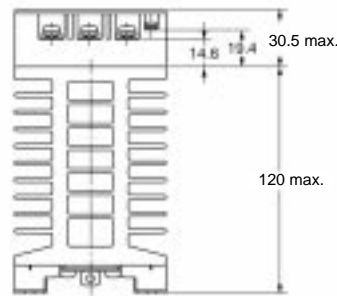
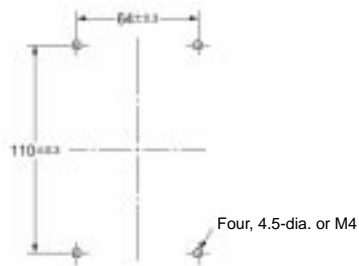

Terminal Arrangement/  
Internal Connections

G3PB-□□□B-3N-VD

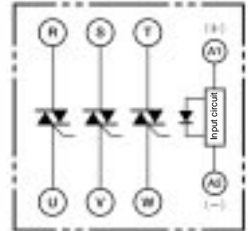

G3PB-□□□B-2N-VD

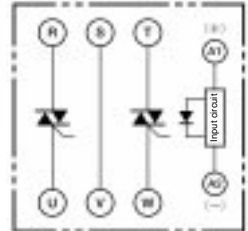

G3PB-235B-3N-VD  
 G3PB-245B-2N-VD  
 G3PB-535B-3N-VD  
 G3PB-545B-2N-VD



Without Terminal Cover

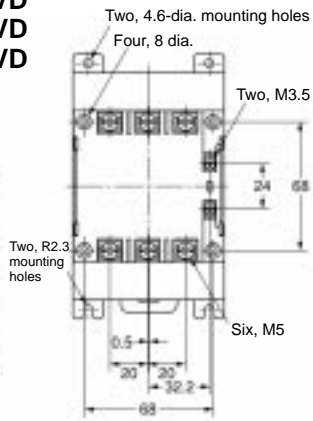

With Terminal Cover

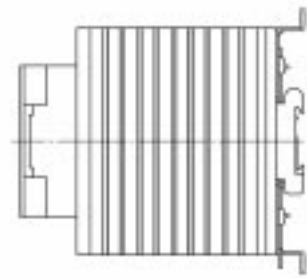
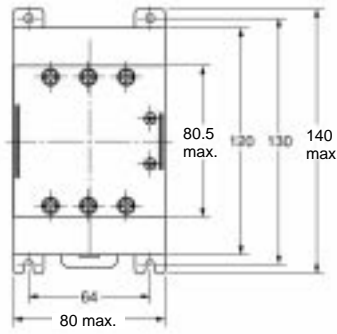

Mounting Hole Dimensions

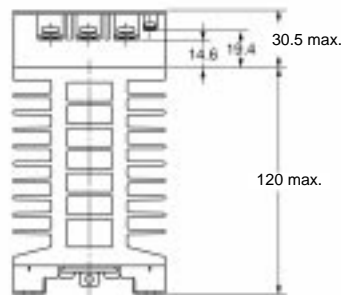
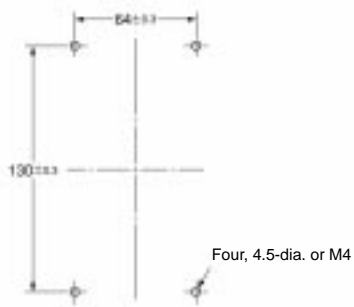

Terminal Arrangement/  
Internal Connections

G3PB-□□□B-3N-VD

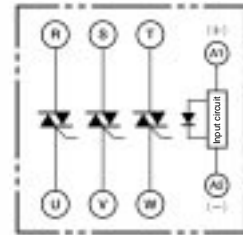

G3PB-□□□B-2N-VD

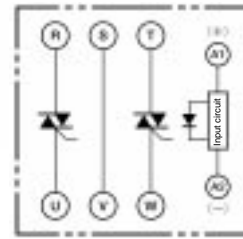



G3PB-245B-3N-VD  
G3PB-545B-3N-VD



Without Terminal Cover

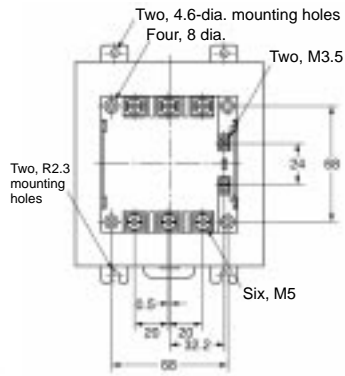

With Terminal Cover

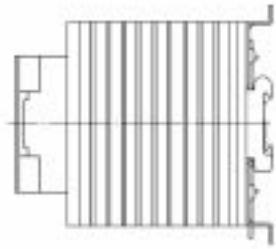
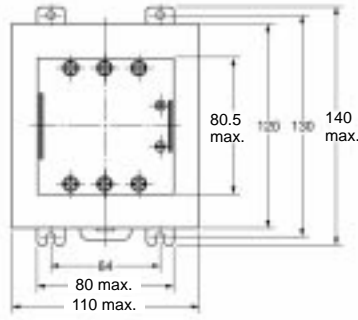

Mounting Hole Dimensions

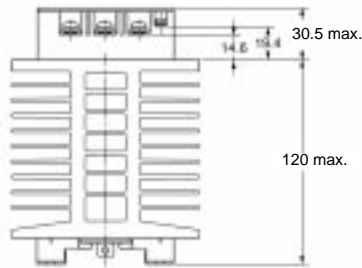
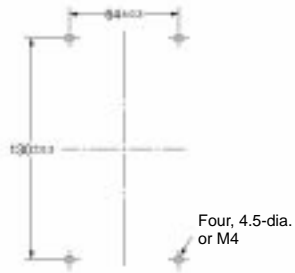

Terminal Arrangement/  
Internal Connections  
G3PB-□□□B-3N-VD

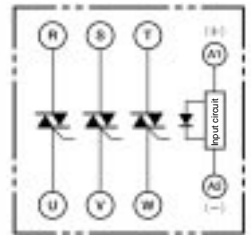

## Precautions

### ! WARNING

Do not touch the terminals (i.e., charged parts) of the G3PB while power is supplied, otherwise an electric shock may be received.

If the G3PB is provided with a terminal cover, be sure to attach the terminal cover to the G3PB before operating the G3PB.

### ! WARNING

The G3PB and radiator are very hot while power is supplied to the G3PB.

Do not touch the G3PB or the radiator while power is supplied to the G3PB or immediately after the G3PB is turned OFF, otherwise a burn may result.

### ! WARNING

Do not touch main circuit terminal of the G3PB immediately after the G3PB is turned OFF, otherwise an electric shock may be received due to the residual charge of the built-in snubber circuit.

### ! WARNING

Be sure to turn OFF the power supply to the G3PB before wiring, otherwise an electric shock may be received.

Mount the terminal cover to the G3PB after wiring. Do not touch the terminals of the G3PB while power is supplied, otherwise an electric shock may be received.

### ! WARNING

Ensure that a short-circuit current does not flow on the load side of the SSR, otherwise the G3PB may be damaged.

## ■ General Precautions

At OMRON, we are constantly working to improve the quality and reliability of our products. SSRs, however, use semiconductors, which are prone to malfunction. Be sure to use SSRs within their rated values.

Use the SSR only in systems that are designed with redundancies, flame protection, counter measures to prevent operation errors, and other countermeasures to prevent accidents involving human life or fires.

1. Do not apply voltages or currents to the G3PB's terminals in excess of the rated values. Doing so may result in malfunction or burning.
2. Do not use the G3PB with terminal screws not properly tightened. Abnormal heating of the terminals may result in burning.
3. Do not obstruct the flow of air around the G3PB and the radiator. Abnormal heating of the G3PB may result in short-circuiting of output elements and burning.
4. Perform wiring and tighten screws according to the instructions given under *Correct Use*. Using the G3PB with incorrect wiring or with the screws not tightened properly may result in burning due to abnormal heating of the G3PB during use.

## ■ Correct Use

### Before Actual Operation

- The G3PB in operation may cause an unexpected accident. Therefore it is necessary to test the G3PB under a variety of conditions that are possible. As for the characteristics of the G3PB, it is necessary to consider differences in characteristics between G3PB Units.
- The ratings in this datasheet are tested values in a temperature range between 15°C and 30°C, a relative humidity range between 25% and 85%, and an atmospheric pressure range between 88 and 106 kPa. It will be necessary to provide the above conditions as well as the load conditions if the user wants to confirm the ratings of actual G3PB Units.

### Mounting Method

Since the Relay is heavy, firmly mount the DIN track and fix both ends with End Plates for DIN-track-mounting models.

### Applicable DIN Tracks

The G3PB can be mounted to TH35-15Fe (IEC60715) DIN tracks. The manufacturers and models of DIN tracks to which mounting is possible are shown in the following table.

Manufacturer	Thickness	
	1.5 mm	2.3 mm
Schneider	AM1-DE200	---
WAGO	210-114, 210-197	210-118
PHOENIX	NS35/15	NS35/15-2.3

### Direct Mounting

When mounting directly onto a panel, mount securely under the following conditions.

Screw diameter: M4

Tightening torque: 0.98 to 1.47 N • m

### Mounted State

#### Vertical Mounting

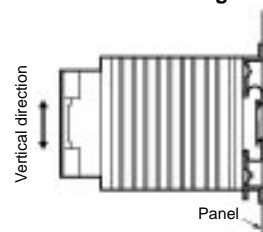

**Note:** Mount the G3PB so that the markings can be read.

#### Horizontal Mounting

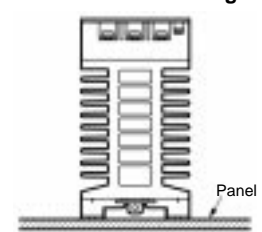

**Note:** When the G3PB is mounted horizontally, use at 50% of the rated load current.

### Close Mounting

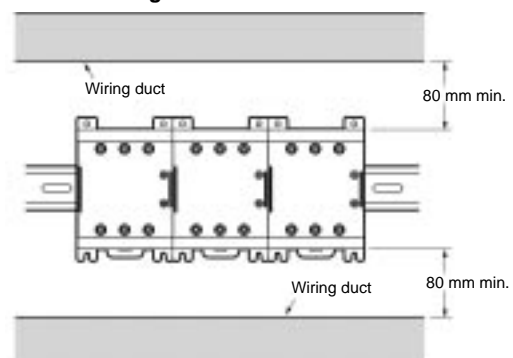

## Wiring

When using crimp terminals, refer to the terminal clearances shown below.

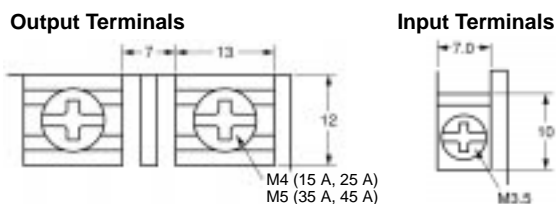

- Be sure that all lead wires are thick enough according to the current.
- Output terminals T1, T2, and T3 are charged regardless of whether the Unit is a 2- or 3-element model that is turned on or off. Do not touch these terminals, otherwise an electric shock may be received.  
To isolate the Unit from the power supply, install an appropriate circuit breaker between the power supply and Unit.  
Be sure to turn off the power supply before wiring the Unit.
- Terminal L2 and terminal T2 of the 2-element model are internally short-circuited to each other. Therefore, connect terminal L2 to the ground terminal side of the power supply. If terminal L2 is connected to a terminal other than the ground terminal, cover all the charged terminals, such as heater terminals, for the prevention of electric shock accidents and ground faults.

## Tightening Torque

Refer to the following and be sure to tighten each screw of the Unit to the specified torque in order to prevent the Unit from malfunctioning.

Item	Screw terminal diameter	Tightening torque
Input terminal	M3.5	0.59 to 1.18 N • m
Output terminal	M4	0.98 to 1.47 N • m
	M5	1.47 to 2.45 N • m

## Operating Conditions

- Do not apply current exceeding the rated current otherwise, the temperature of the G3PB may rise excessively.
- Be sure to prevent the ambient temperature rising due to the heat radiation of the G3PB. If the G3PB is mounted inside a panel, install a fan so that the interior of the panel is fully ventilated.
- Do not use the G3PB if heat dissipation fins have been bent as a result of, for example, dropping the G3PB. If used in this state, the G3PB may be damaged due to the decreased heat dissipation capacity.
- Only use the G3PB with loads that are within the rated values. Using the G3PB with loads outside the rated values may result in malfunction, damage, or burning.
- Use a power supply within the rated frequency range. Using a power supply outside the rated frequency range may result in malfunction, damage, or burning.
- Keep wiring separate from high-voltage power lines and use wires of an appropriate length, otherwise malfunction and damage may result due to induction.
- As protection against accidents due to short-circuiting, be sure to install protective devices, such as fuses and no-fuse breakers on the power supply side.

## ■ Operating and Storage Environments

### 1. Operating Ambient Temperature

The rated value for the ambient operating temperature of the G3PB is for when there is no built-up heat. For this reason, under conditions where heat dissipation is not good due to poor ventilation, and where heat may build up easily, the actual temperature of the G3PB may exceed the rated value resulting in malfunction on burning.

When using the G3PB, design the system to allow heat dissipation sufficient to stay below the *Load Current vs. Ambient Temperature* characteristic curve. Note also that the ambient temperature of the G3PB may increase as a result of environmental conditions (e.g., climate, air-conditioning) and operating conditions (e.g., mounting in an airtight panel).

### 2. Operating and Storage Locations

Do not use or store the G3PB in the following locations. Doing so may result in damage, malfunction, or deterioration of performance characteristics.

- Do not use or store in locations subject to direct sunlight.
- Do not use in locations subject to ambient temperatures outside the range  $-20$  to  $60^{\circ}\text{C}$ .
- Do not use in locations subject to relative humidity outside the range 45% to 85% or locations subject to condensation as the result of severe changes in temperature.
- Do not store in locations subject to ambient temperatures outside the range  $-30$  to  $70^{\circ}\text{C}$ .
- Do not use or store in locations subject to corrosive or flammable gases.
- Do not use or store in locations subject to dust (especially iron dust) or salts.
- Do not use or store in locations subject to shock or vibration.
- Do not use or store in locations subject to exposure to water, oil, or chemicals.

### 3. Transportation

When transporting the G3PB, observe the following points. Not doing so may result in damage, malfunction, or deterioration of performance characteristics.

- Do not drop the G3PB or subject it to severe vibrations or shock.
- Do not transport the product if it is wet.

### 4. Vibration and Shock

Do not subject the SSR to excessive vibration or shock. Otherwise the SSR may malfunction and internal components may be damaged.

To prevent the SSR from abnormal vibration, do not install the G3PB in locations or by means that will subject it to the vibrations from other devices, such as motors.

### 5. Solvents

Do not allow the G3PB to come in contact with solvents such as thinners or gasoline. Doing so will dissolve the markings on the SSR.

### 6. Oil

Do not allow the G3PB terminal cover to come in contact with oil. Doing so will cause the cover to crack and become cloudy.

## ■ Operation

### 1. Leakage Current

A leakage current flows through a snubber circuit in the G3PB even when there is no input. Therefore, always turn OFF the power to the input or load and check that it is safe before replacing or wiring the G3PB.

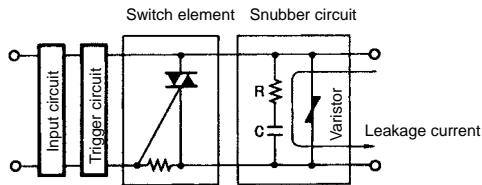

### 2. Screw Tightening Torque

Tighten the G3PB terminal screws properly. If the screws are not tight, the G3PB will be damaged by heat generated when the power is ON.

### 3. Mounting

Do not perform mounting with oil or metal powder on your hands. Doing so may result in damage to the G3PB.

### 4. Dropping

Be careful not to drop the G3PB during mounting. The G3PB weighs approximately 1.25 to 2.0 kg and could cause injury if dropped on any part of your body.

**ALL DIMENSIONS SHOWN ARE IN MILLIMETERS.**

To convert millimeters into inches, multiply by 0.03937. To convert grams into ounces, multiply by 0.03527.

Cat. No. J112-E1-2 **In the interest of product improvement, specifications are subject to change without notice.**

## OMRON Corporation

Industrial Automation Company

Industrial Devices and Components Division H.Q.  
 Industrial Control Components Department  
 Shiokoji Horikawa, Shimogyo-ku,  
 Kyoto, 600-8530 Japan  
 Tel: (81)75-344-7119/Fax: (81)75-344-7149

Printed in Japan  
 0301-2M (0299) (A)